

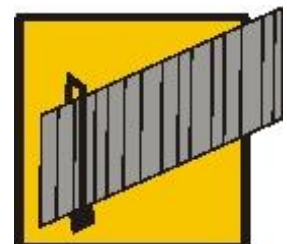

American way of key switch

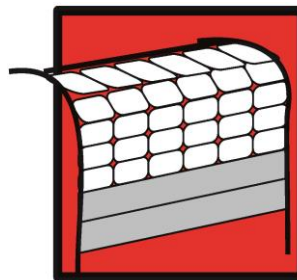

- mechanical security plate
- plug connection of electronic contacts
- easy flush mounting due to inlying cap
- attractive and sturdy aluminum enclosure, IP54
- switches available as one or two way with momentary or latching function
- available as single or double pole versions
- patented one screw mounting system
- custom specific front plate available

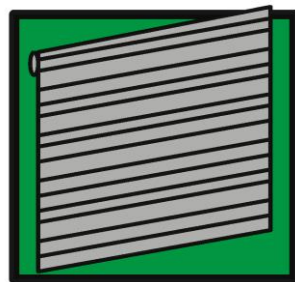
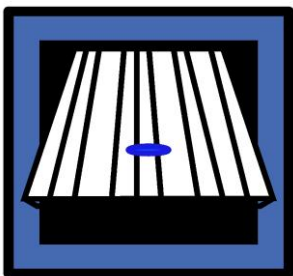

(surface mount)

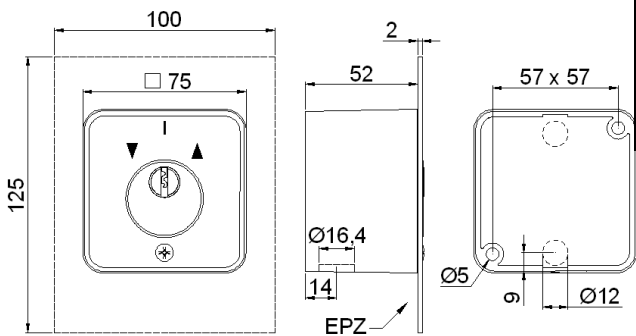

surface mount	
Art.-No.	
081.1301.10	S-ARZ 1-2T(R)/1 for one door
081.1301.00 (without cylinder)	S-ARZ 1-2T(R)/2 for one door
081.1302.10	S-ARZ 1-2T(R)/1 for two doors
081.1302.00 (without cylinder)	S-ARZ 1-2T(R)/2 for two doors

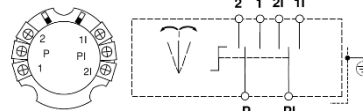

(flush mount)

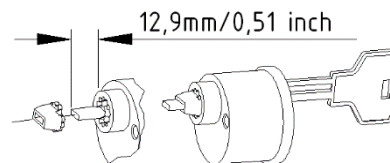

switching power	
Ue	240V/AC
Ui	300V
Lth	16A
Le	5A
	16 A gl
	AC 15
	Max 1,5mm ²
	30 T 50

flush mount	
Art.-No.	
181.1301.10	S-ERZ 1-2T(R)/1 for one door
181.1301.00 (without cylinder)	S-ERZ 1-2T(R)/2 for one door
181.1302.10	S-ERZ 1-2T(R)/1 for two doors
181.1302.00 (without cylinder)	S-ERZ 1-2T(R)/2 for two doors



geba Handels- und Entwicklungs-
gesellschaft mbH
Wecostrasse 7-11
D - 53783 Eitorf

Tel.: +49/ (0)22 43/ 88 04 - 0
Fax: +49/ (0)22 43/ 88 04 - 199
Email: mailbox@geba.net

www.geba.net